

Article number: 2310431063S

Description: E+G Levelling elements  
LX.30-SW17-M8X53-S

## Measures

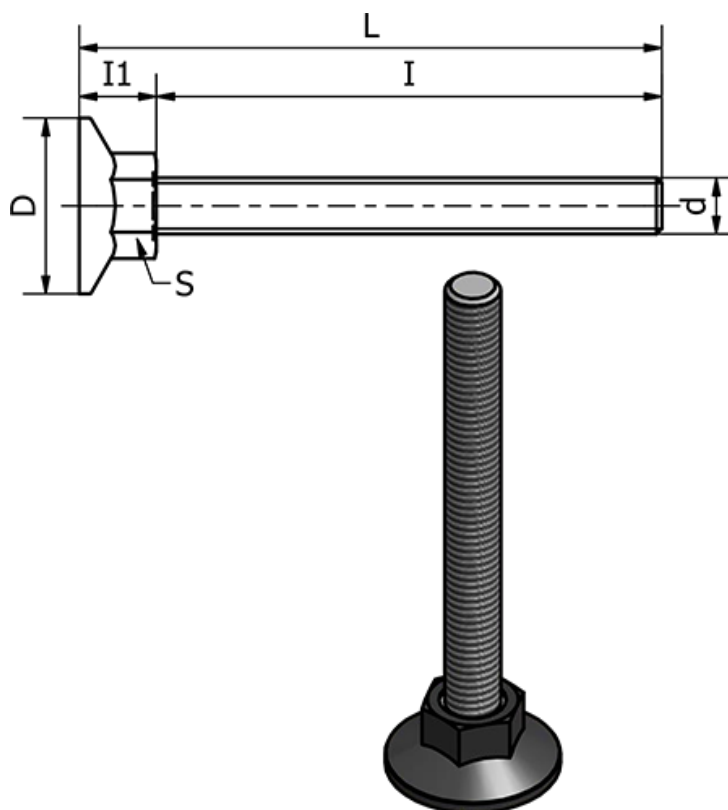

d	= M8
D	= 30
I	= 53
I1	= 12
L	= 65
S	= 17
Static load in (N)	= 2500
Type	= Forzinket

Weight (g) = -